

## MICRO SWITCH™ Premium Large Snap-Action Series

### Snap-Action Switches & Accessories



#### DESCRIPTION

MICRO SWITCH™ premium large snap-action series are designed for repeatability and enhanced life. These series of precision switches feature application-specific characteristics. From double-break circuitry to handling very high loads, MICRO SWITCH™ premium large snap-action series are suitable for a variety of applications.

**DT Series** switches consist of two independent single-pole double throw circuits in one housing actuated by one actuator. The terminals are separated by a non-conductive shield to reduce shorting.

**MT Series** magnetic blow-out switches are designed to switch high-capacity (125 Vdc/250 Vdc) systems. An integral magnet around the contact gap protects the contacts by deflecting the arc. Vents between the cover and housing allow the hot gas to escape.

Easy to gang mount, **MN Series** twin-break circuit type switches are for use with limit or control mechanisms on machine tools, presses, or other industrial equipment.

MICRO SWITCH™ **TB Series** miniature double-break basic switches are basic double-break units that offer a means of controlling isolated circuits. Each circuit may be driven by an independent voltage source.

#### FEATURES



- Broad and deep array of product options and characteristics
- SPDT circuits
- High capacity Vdc
- Broad range of accessories, including brackets and actuators
- Rugged construction
- Reliable performance with enhanced mechanical life
- Various international agency approvals

#### POTENTIAL APPLICATIONS



- Building controls and fire suppression systems
- dc motors
- Door latches
- HVAC
- Industrial equipment
- Irrigation systems
- Machine tools
- Manually operated devices
- Medical/dental equipment
- Office equipment
- Presses
- Solenoids
- Semi-trailer trucks
- Test instruments
- Timing devices
- Valves
- Welders

# MICRO SWITCH™ Premium Large Snap-Action Series

## SPECIFICATIONS

			
<b>SERIES</b>	<b>DT</b>	<b>MT</b>	<b>MN</b>
Differentiator	same size as the MICRO SWITCH™ BZ Series, but with two circuits	contains a magnet for very high dc loads	double-break circuitry
Use	design permits several different wiring configurations	designed to switch high capacity (125 Vdc and 250 Vdc) systems	limit or control mechanisms
Potential applications	HVAC, irrigation systems, manually operated devices, medical/dental equipment, office equipment, semi-trailer trucks, test instruments, timing devices, valves	dc motors, solenoids	machine tools, presses, other industrial equipment
Ampere rating	10 A	10 A	15 A
Circuitry	DPDT	SPDT	2 CKT DB
Operating force	3,34 N to 5,56 N [12.0 oz to 20.0 oz] max.	3,34 N to 5,00 N [12 oz to 18 oz] max.	1,95 N to 3,1 N [7.0 oz to 11.0 oz]
Termination	screw	solder, screw	screw
Actuator	pin plunger, straight plunger, straight lever, reversed lever, roller lever	pin plunger, straight lever, roller lever, flexible leaf, flexible leaf with roller	pin plunger
Voltage	125 Vac, 250 Vac, 28 Vdc	125 Vdc, 250 Vdc	480 Vac
Agency approvals	UL recognized; CSA certified	UL recognized	UL recognized; CSA certified
Operating temperature	-55 °C to 85 °C [-67 °F to 185 °F]	-55 °C to 82 °C [-67 °F to 180 °F]	-55 °C to 85 °C [-67 °F to 185 °F]
Contacts	silver	silver	silver
Housing	general purpose phenolic	arc resistant melamine	general purpose phenolic
Sealing	no	no	no
Expected mechanical life	–	100,000 operations	10,000,000 cycles

## Snap-Action Switches & Accessories

			
<b>SERIES</b>	<b>TB</b>	<b>WZ/WA/WM/WE</b>	<b>YZ/YA/YM/YE</b>
Differentiator	smaller double-break switch	SPNC contacts	SPNO contacts
Use	offer a means of controlling isolated circuits	ideal for high cost-of-failure applications	
Potential applications	control systems, industrial equipment, and welders	communication systems, elevators/lifts, HVAC, irrigation systems, semi-trailer trucks, and valves	
Ampere rating	10 A	15 A (WZ/YZ), 20 A (WA/YA), 22 A (WM/YM), 25 A (WE/YE)	
Circuitry	2 CKT DB	SPNC	SPNO
Operating force	1,95 N to 3,89 N [7 oz to 14 oz] max.	1.0 oz to 28 oz	
Termination	screw, solder	quick connect, solder, screw	
Actuator	pin plunger	pin plunger, overtravel plunger, straight, roller, flexible leaf roller, flexible leaf	
Voltage	250 Vac	115 Vac, 125 Vac, 250 Vac	
Agency approvals	UL recognized, CSA certified	UL, CSA, ENEC, CE (varies by specific model)	
Operating temperature	-55 °C to 125 °C [-67 °F to 257 °F]	-55 °C to 85 °C [-67 °F to 185 °F]	
Contacts	silver	silver, silver cadmium oxide	
Housing	general purpose phenolic	general purpose phenolic	
Sealing	none	environment sealing option available	
Expected mechanical life	–	up to 20,000,000 cycles at 95% survival	

# MICRO SWITCH™ Premium Large Snap-Action Series

## DT SERIES LEVER OPTIONS & DIMENSIONS mm/in

Lever/ Terminals	Dimensions	Lever/ Terminals	Dimensions
Pin plunger/ Screw	<p>MOUNTING HOLES ACCEPT PINS OR SCREWS OF 3.53/.139 DIA</p>	Straight/ Screw	
Straight/ Screw		Roller lever/ Screw	<p>9,4/.37 D × 3,8/.15 W ROLLER</p>
Roller lever/ Screw	<p>9,4/.37 D × 3,8/.15 W ROLLER</p>	Roller lever/ Screw	<p>9,4/.37 D × 3,8/.15 W ROLLER</p>
Roller lever/ Screw	<p>9,4/.37 D × 3,8/.15 W ROLLER</p>	Roller lever/ Screw	<p>9,4/.37 D × 3,8/.15 W ROLLER</p>
Straight plunger/ Screw			

# Snap-Action Switches & Accessories

## MT SERIES LEVER OPTIONS & DIMENSIONS mm/in

Lever/ Terminals	Dimensions	Lever/ Terminals	Dimensions
Pin plunger/ Screw		Straight lever/ Screw	
Roller lever/ Screw		Flexible leaf/ Screw	
Flexible leaf roller/ Screw			

## 3MN SERIES LEVER OPTIONS & DIMENSIONS mm/in

Lever/ Terminals	Dimensions
Pin plunger/ Screw	

# MICRO SWITCH™ Premium Large Snap-Action Series

## TB SERIES LEVER OPTIONS & DIMENSIONS mm/in

Lever/ Terminals	Dimensions	Lever/ Terminals	Dimensions
Pin plunger/ Screw		Pin Plunger/ Solder	
Pin plunger/ Solder front		Pin plunger/ Solder front four circuit	

# Snap-Action Switches & Accessories

## WZ/WA/WM/WE SERIES LEVER OPTIONS & DIMENSIONS mm/in

All products shown with screw terminals. See next page for available terminal options.

Lever	Dimensions	Lever	Dimensions
<b>Pin plunger</b>		<b>Pin plunger</b>	
<b>Overtravel plunger</b>		<b>Overtravel plunger</b>	
<b>Bushing mount overtravel plunger</b>		<b>Bushing mount overtravel plunger</b>	
<b>Flexible leaf actuator</b>		<b>Flexible leaf actuator</b>	

# MICRO SWITCH™ Premium Large Snap-Action Series

Continued - WZ/WA/WM/WE SERIES LEVER OPTIONS & DIMENSIONS mm/in

<p><b>Straight lever with external return spring</b></p>		<p><b>Straight lever</b></p>	
<p><b>Roller lever</b></p>		<p><b>Pin plunger with manual reset</b></p>	

## WZ/WA/WM/WE SERIES AVAILABLE TERMINALS

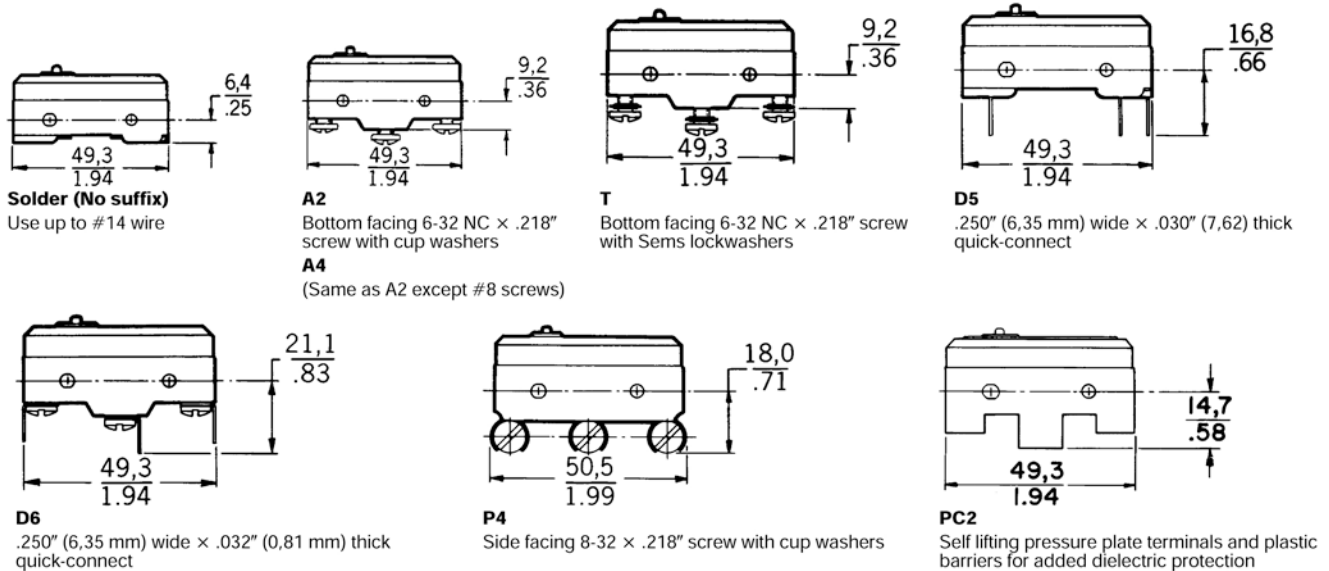



# Snap-Action Switches & Accessories

## LARGE SNAP-ACTION SWITCH ACCESSORIES

### Brackets



	<b>8MA1</b>	<b>8MA2</b>	<b>17MA1-B</b>
Description	Adjustable mounting bracket with adjustment slot on left	Adjustable mounting bracket with adjustment slot on right	Conversion mounting bracket
Housing material	Steel	Steel	Corrosion-resistant metal
Measurements	60,2 mm W x 21,3 mm H x 7,4 mm D [2.37 in W x 0.84 in H x 0.29 in D]		66,8 mm W x 19,0 mm D [2.63 in W x 0.75 in D]
Features	sturdy plated steel construction; fast, easy screwdriver adjustment; can be used with all standard basic switches		converts standard basic switches from side to top mount; corrosion resistant; snaps into switch mounting holes without tools

### Die-cast zinc enclosures



	<b>3PA1</b>	<b>3PA28</b>	<b>3PA2</b>
Description	mounted from either side through 3,55 mm [0.140 in] dia. holes on 25,4 mm [1.0 in] centers	mounted from either side through 3,55 mm [0.140 in] dia. holes on 25,4 mm [1.0 in] centers. 1/2-14 NPSM internal thread conduit hub	switch secured in enclosure; two 4,37 mm [0.172 in] dia. holes in flange accept #8 screws for mounting on 41,3 mm [1.625 in] centers
Housing material	die-cast zinc enclosure (side mount)	die-cast zinc enclosure (side mount)	die-cast zinc enclosure (flange mount)
Measurements	74,8 mm W x 42,9 mm H x 25,4 mm D [2.95 in W x 1.69 in H x 1.00 in D]	74,8 mm W x 42,9 mm H x 25,4 mm D [2.95 in W x 1.69 in H x 1.00 in D]	74,8 mm W x 42,9 mm H x 25,4 mm D [2.95 in W x 1.69 in H x 1.00 in D]
Features	protects the switch from physical abuse and personnel from contact with exposed terminals		

### Plastic thermal enclosures



	<b>5PA1</b>	<b>5PA2</b>	<b>5PA3</b>
Description	Plastic terminal enclosure used with solder terminal switches	Plastic terminal enclosure use with screw terminal switches	Plastic terminal enclosure used with either solder or screw terminal switches with auxiliary actuators assembled
Housing material	plastic	plastic	plastic
Measurements	52,8 mm W x 16,1 mm H [2.08 in W x 0.64 in H]	52,8 mm W x 20,2 mm H x 21,0 mm D [2.08 in W x 0.80 in H x 0.83 in D]	52,8 mm W x 20,2 mm H x 21,0 mm D [2.08 in W x 0.80 in H x 0.83 in D]
Features	easy to use; screw and solder terminal versions; protect personnel from contact with exposed terminals		

# MICRO SWITCH™ Premium Large Snap-Action Series

## OPERATING CHARACTERISTICS

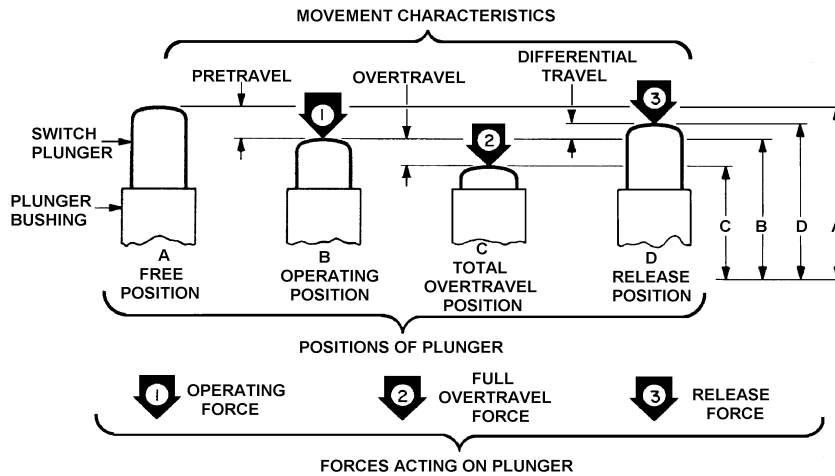

<b>Differential Travel-DT</b>	Plunger or actuator travel from point where contacts “snap-over” to point where they “snap-back.”
<b>Free Position-FP</b>	Position of switch plunger or actuator when no external force is applied.
<b>Full Overtravel Force</b>	Force required to attain full overtravel of actuator.
<b>Operating Position-OP</b>	Position of switch plunger or actuator at which point contacts snap from normal to operated position. With flexible or adjustable actuators, the operating position is measured from the end of the lever or its maximum length. Location of operating position measurement shown on mounting dimension drawings.
<b>Operating Force-OF</b>	Amount of force applied to switch plunger or actuator to cause the contact “snap-over.” Note in the case of adjustable actuators, the force is measured from the maximum length position of the lever.
<b>Overtravel-OT</b>	Plunger or actuator travel safely available beyond operating position.
<b>Pretravel-PT</b>	Distance or angle traveled in moving plunger or actuator from free position to operating position.
<b>Release Force-RF</b>	Amount of force still applied to switch plunger or actuator at the moment contacts snap from operated position to non-operated position.
<b>Total Travel</b>	Distance from actuator free position to overtravel limit position.

# Snap-Action Switches & Accessories

## **WARNING**

### **PERSONAL INJURY**

DO NOT USE these products as safety or emergency stop devices or in any other application where failure of the product could result in personal injury.

**Failure to comply with these instructions could result in death or serious injury.**

## **WARNING**

### **MISUSE OF DOCUMENTATION**

- The information presented in this product sheet is for reference only. Do not use this document as a product installation guide.
- Complete installation, operation, and maintenance information is provided in the instructions supplied with each product.

**Failure to comply with these instructions could result in death or serious injury.**

## **WARRANTY/REMEDY**

Honeywell warrants goods of its manufacture as being free of defective materials and faulty workmanship. Honeywell's standard product warranty applies unless agreed to otherwise by Honeywell in writing; please refer to your order acknowledgement or consult your local sales office for specific warranty details. If warranted goods are returned to Honeywell during the period of coverage, Honeywell will repair or replace, at its option, without charge those items it finds defective. **The foregoing is buyer's sole remedy and is in lieu of all other warranties, expressed or implied, including those of merchantability and fitness for a particular purpose. In no event shall Honeywell be liable for consequential, special, or indirect damages.**

While we provide application assistance personally, through our literature and the Honeywell web site, it is up to the customer to determine the suitability of the product in the application.

Specifications may change without notice. The information we supply is believed to be accurate and reliable as of this printing. However, we assume no responsibility for its use.

## **SALES AND SERVICE**

Honeywell serves its customers through a worldwide network of sales offices, representatives and distributors. For application assistance, current specifications, pricing or name of the nearest Authorized Distributor, contact your local sales office or:

**E-mail:** [info.sc@honeywell.com](mailto:info.sc@honeywell.com)

**Internet:** [www.honeywell.com/sensing](http://www.honeywell.com/sensing)

### **Phone and Fax:**

Asia Pacific	+65 6355-2828
	+65 6445-3033 Fax
Europe	+44 (0) 1698 481481
	+44 (0) 1698 481676 Fax
Latin America	+1-305-805-8188
	+1-305-883-8257 Fax
USA/Canada	+1-800-537-6945
	+1-815-235-6847
	+1-815-235-6545 Fax