

# Product data sheet

## Characteristics

# XS1L04PA310S

Inductive proximity sensors XS, inductive sensor XS1 Ø4, L42mm, brass, Sn1mm, 5..24VDC, M8



Product availability: Stock - Normally stocked in distribution facility

Price\*: 122.80 USD



### Main

Range of product	Telemecanique Inductive proximity sensors XS
Series name	General purpose
Sensor type	Inductive proximity sensor
Device application	-
Sensor name	XS1
Sensor design	Cylindrical Ø 4 mm plain
Size	42 mm
Body type	Fixed
Detector flush mounting acceptance	Flush mountable
Material	Metal
Type of output signal	Discrete
Wiring technique	3-wire
[Sn] nominal sensing distance	0.04 ln (1 mm)
Discrete output function	1 NO
Output circuit type	DC
Discrete output type	PNP
Electrical connection	Male connector M8, 3 pins
[Us] rated supply voltage	5...24 V DC
Switching capacity in mA	<= 100 mA with overload and short-circuit protection
IP degree of protection	IP67 conforming to IEC 60529

### Complementary

Detection face	Frontal
Front material	PPS
Enclosure material	Nickel Plated Brass
Operating zone	0.00...0.03 ln (0...0.8 mm)
Status LED	Output state: 1 LED (yellow)
Supply voltage limits	5...30 V DC
Switching frequency	<= 5000 Hz

Maximum voltage drop	<2 V (closed)
Current consumption	<= 10 mA no-load
Maximum delay first up	5 Ms
Maximum delay response	1 Ms
Maximum delay recovery	1 Ms
Marking	CE
Threaded length	0.00 In (0 mm)
Length	1.65 In (42 mm)
Net weight	0.02 Lb(US) (0.01 kg)

## Environment

Product certifications	CSA UL
Ambient air temperature for operation	-13...158 °F (-25...70 °C)
Ambient air temperature for storage	-40...185 °F (-40...85 °C)
Vibration resistance	25 gn +/- 2 mm 10...55 Hz)IEC 60068-2-6
Shock resistance	50 gn 11 ms IEC 60068-2-27

## Ordering and shipping details

Category	22486 - SENSORS, PROXIMITY
Discount Schedule	DS2
GTIN	03389110910032
Nbr. of units in pkg.	1
Package weight(Lbs)	0.67 Oz (19 g)
Returnability	Yes
Country of origin	FR

## Packing Units

Unit Type of Package 1	PCE
Package 1 Height	1.61 In (4.1 cm)
Package 1 width	2.56 In (6.5 cm)
Package 1 Length	3.74 In (9.5 cm)
Unit Type of Package 2	BAG
Number of Units in Package 2	1
Package 2 Weight	0.67 Oz (19 g)
Package 2 Height	0.24 In (0.6 cm)
Package 2 width	7.87 In (20 cm)
Package 2 Length	5.91 In (15 cm)
Unit Type of Package 3	S02
Number of Units in Package 3	44
Package 3 Weight	2.62 Lb(US) (1.19 kg)
Package 3 Height	5.91 In (15 cm)
Package 3 width	11.81 In (30 cm)
Package 3 Length	15.75 In (40 cm)

## Offer Sustainability

Sustainable offer status	Green Premium product
California proposition 65	WARNING: This product can expose you to chemicals including: Diisononyl phthalate (DINP), which is known to the State of California to cause cancer, and Diisodecyl phthalate (DIDP), which is known to the State of California to cause birth defects or other reproductive harm. For more information go to <a href="http://www.P65Warnings.ca.gov">www.P65Warnings.ca.gov</a>
REACH Regulation	<a href="#">REACH Declaration</a>
EU RoHS Directive	Pro-active compliance (Product out of EU RoHS legal scope) <a href="#">EU RoHS Declaration</a>
Mercury free	Yes
RoHS exemption information	<a href="#">Yes</a>
Environmental Disclosure	<a href="#">Product Environmental Profile</a>
Circularity Profile	<a href="#">End Of Life Information</a>

## Contractual warranty

Warranty	18 months
----------	-----------

Dimensions

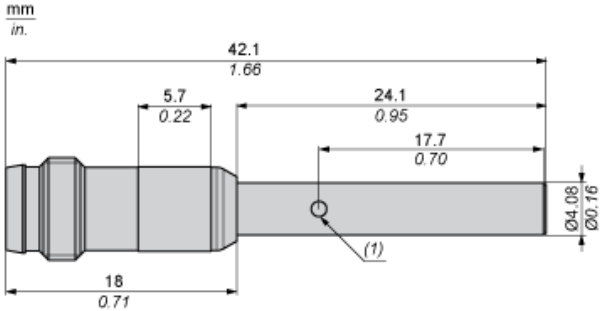

(1) LED

---

Minimum Mounting Distances in mm

---

Side by side

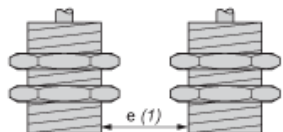

$e (1) \geq 2 \text{ mm} / 0.79 \text{ in.}$

Face to face

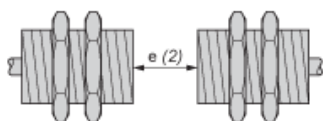

$e (2) \geq 2 \text{ mm} / 0.47 \text{ in.}$

Facing a metal object

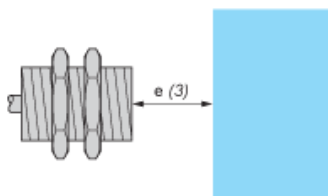

$e (3) \geq 3 \text{ mm} / 0.12 \text{ in.}$

Mounted in a metal support

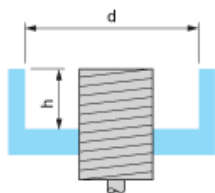

$d \geq 4 \text{ mm} / 0.16 \text{ in.}$

$h \geq 0 \text{ mm} / 0 \text{ in.}$

Tightening torque : 1.6 N.m. (values obtained with washers mounted)

Wiring Schemes

M8 Connector

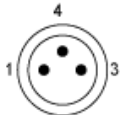

PNP

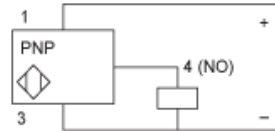

Performance Curves

Standard Steel Target (mm) : 5x5x1

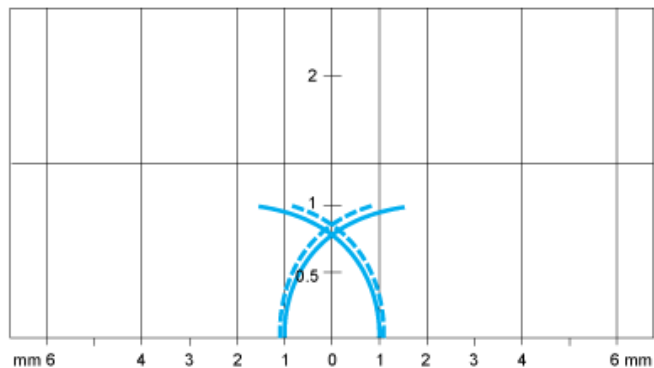

- Pick-up points
- - - Drop-out points (object approaching from the side)
- (y) Sensing distance in mm

Product Life Status : **Commercialised**