

Product data sheet

Characteristics

XS1M08PC410D

Inductive proximity sensors XS, inductive sensor XS1 M8, L61mm, stainless, Sn1.5 mm, 12...24 VDC, M12



Product availability: Stock - Normally stocked in distribution facility

Price*: 108.00 USD



Main

Range of product	Telemecanique Inductive proximity sensors XS
Series name	General purpose
Sensor type	Inductive proximity sensor
Sensor name	XS1
Sensor design	Cylindrical M8
Size	62 mm
Body type	Fixed
Detector flush mounting acceptance	Flush mountable
Material	Stainless steel
Type of output signal	Discrete
Wiring technique	4-wire
[Sn] nominal sensing distance	0.06 In (1.5 mm)
Discrete output function	1 NO + 1 NC
Output circuit type	DC
Discrete output type	PNP
Electrical connection	Male connector M12, 4 pins
[Us] rated supply voltage	12...24 V DC reverse polarity protection
Switching capacity in mA	<= 200 mA overload and short-circuit protection
IP degree of protection	IP67 conforming to IEC 60529

Complementary

Thread type	M8 x 1
Detection face	Frontal
Front material	PPS
Enclosure material	Stainless steel 303
Operating zone	0.00...0.05 In (0...1.2 mm)
Differential travel	1...15% of Sr
Status LED	Output state: 1 LED (yellow)

Supply voltage limits	10...36 V DC
Switching frequency	<= 5000 Hz
Maximum voltage drop	<2 V (closed)
Current consumption	0...10 mA no-load
Maximum delay first up	5 Ms
Maximum delay response	0.1 Ms
Maximum delay recovery	0.1 Ms
Marking	CE
Threaded length	1.57 ln (40 mm)
Length	2.44 ln (62 mm)
Net weight	0.06 Lb(US) (0.025 kg)

Environment

Product certifications	CSA UL
Ambient air temperature for operation	-13...158 °F (-25...70 °C)
Ambient air temperature for storage	-40...185 °F (-40...85 °C)
Vibration resistance	25 gn +/- 2 mm 10...55 Hz)IEC 60068-2-6
Shock resistance	50 gn 11 ms IEC 60068-2-27

Ordering and shipping details

Category	22486 - SENSORS, PROXIMITY
Discount Schedule	DS2
GTIN	03389110547214
Nbr. of units in pkg.	1
Package weight(Lbs)	1.13 Oz (32 g)
Returnability	Yes
Country of origin	FR

Packing Units

Unit Type of Package 1	PCE
Package 1 Height	1.65 ln (4.2 cm)
Package 1 width	2.60 ln (6.6 cm)
Package 1 Length	3.74 ln (9.5 cm)
Unit Type of Package 2	BAG
Number of Units in Package 2	1
Package 2 Weight	1.13 Oz (32 g)
Package 2 Height	0.79 ln (2 cm)
Package 2 width	7.87 ln (20 cm)
Package 2 Length	5.91 ln (15 cm)
Unit Type of Package 3	S02
Number of Units in Package 3	44
Package 3 Weight	3.98 Lb(US) (1.806 kg)
Package 3 Height	5.91 ln (15 cm)
Package 3 width	11.81 ln (30 cm)
Package 3 Length	15.75 ln (40 cm)

Offer Sustainability

Sustainable offer status	Green Premium product
California proposition 65	WARNING: This product can expose you to chemicals including: Diisononyl phthalate (DINP), which is known to the State of California to cause cancer, and Diisodecyl phthalate (DIDP), which is known to the State of California to cause birth defects or other reproductive harm. For more information go to www.P65Warnings.ca.gov
REACH Regulation	REACH Declaration
EU RoHS Directive	Pro-active compliance (Product out of EU RoHS legal scope) EU RoHS Declaration
Mercury free	Yes
RoHS exemption information	Yes
Environmental Disclosure	Product Environmental Profile
Circularity Profile	End Of Life Information

Contractual warranty

Warranty	18 months
----------	-----------

Dimensions

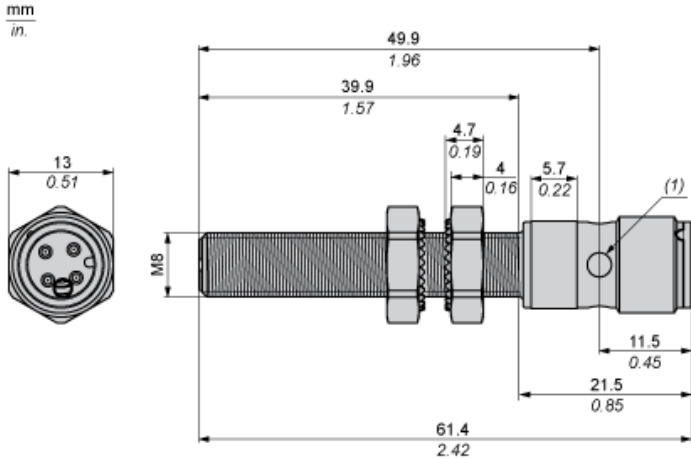

(1) LED

Minimum Mounting Distances

Side by side

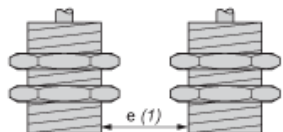

$e (1) \geq 3 \text{ mm} / 0.12 \text{ in.}$

Face to face

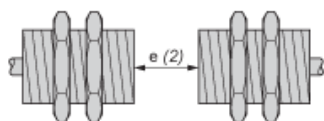

$e (2) \geq 8 \text{ mm} / 0.71 \text{ in.}$

Facing a metal object

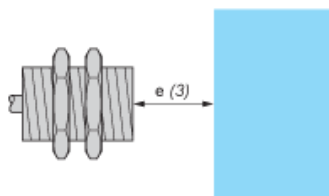

$e (3) \geq 4.5 \text{ mm} / 0.18 \text{ in.}$

Wiring Schemes

M12 connector

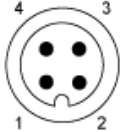

PNP 4-wire

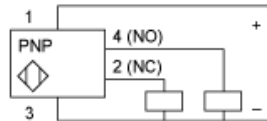

Performance Curves

Standard Steel Target : 8x8x1 mm

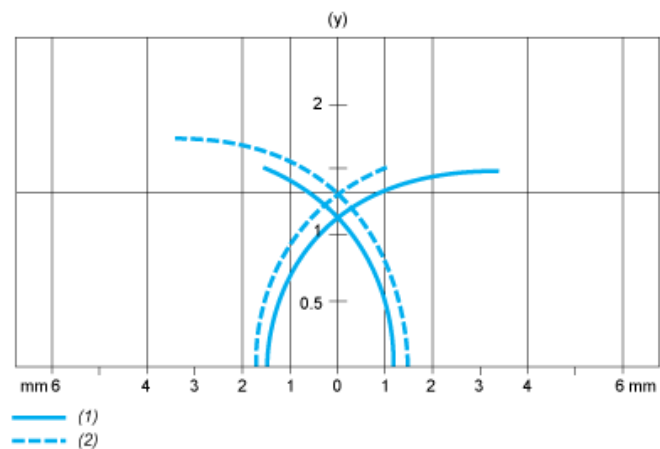

- (1) Pick-up points
- (2) Drop-out points (object approaching from the side)
- (y) Sensing distance in mm

Product Life Status : Commercialised